

ABBREVIATIONS

EA: Exhaust Air to outside
 OA: Outside Air intake
 RA: Room Air to be exhausted
 SA: Supply Air to inside

INSTALLATION ORIENTATION

Unit must be installed in orientation shown.

NOTE

1. UNLESS OTHERWISE SPECIFIED, DIMENSIONS ARE ROUNDED TO THE NEAREST EIGHTH OF AN INCH.

2. SPECIFICATIONS MAY BE SUBJECT TO CHANGE WITHOUT NOTICE.

3. FOR PIPE CONNECTION DETAILS REFER TO CORES OR UNIT SELECTION SUBMITTAL.

4. UNIT, UNIT DOORS, AND COILS CANNOT BE MIRRORED.

5. FOR PROJECT SPECIFIC DRAWINGS REFER TO PROJECT SUBMITTAL.

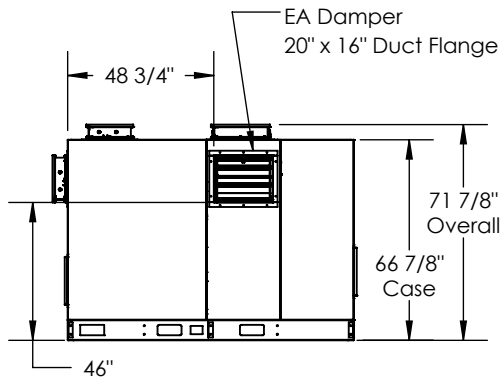
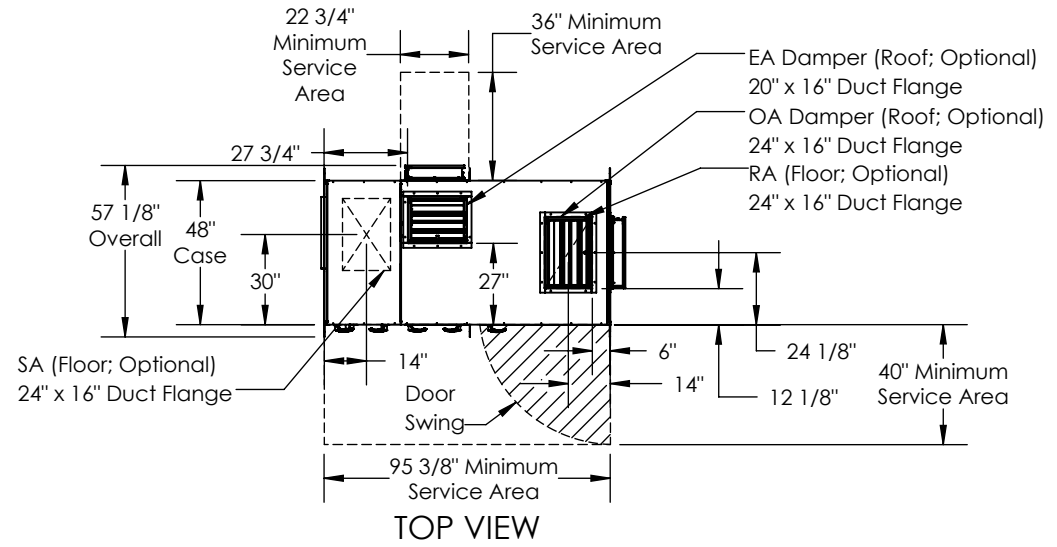

BACK VIEW

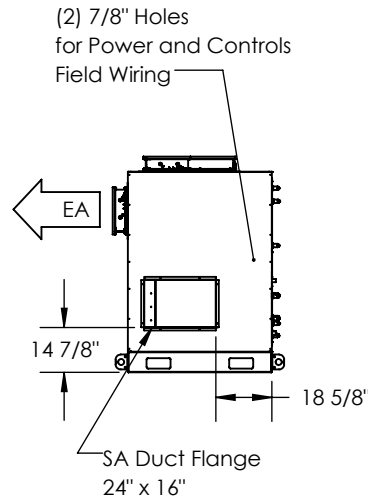

LEFT VIEW

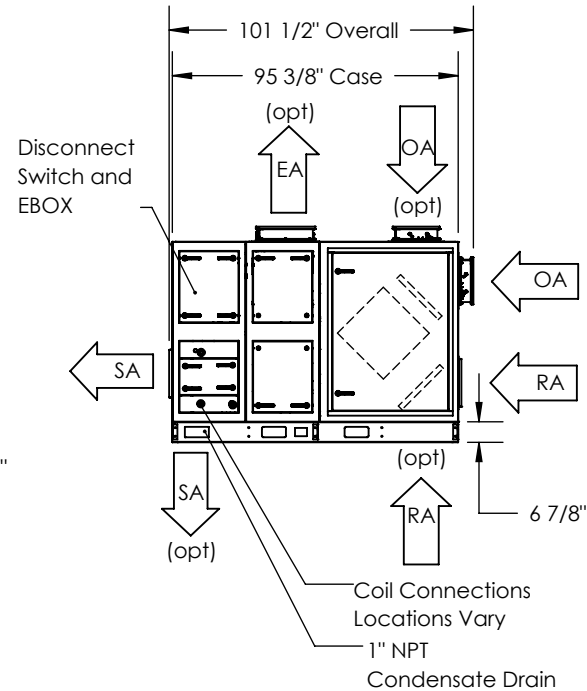

FRONT VIEW

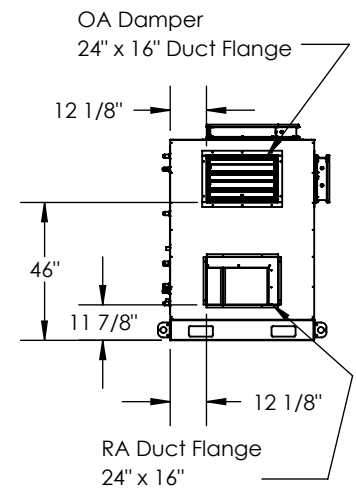

RIGHT VIEW

Model: DN-2JIN ERV+COIL 1"
 Drawing Type: Unit Dimension
 Version: DEC18

Coil Options: DX, CW, HP, HGRH, HW, Steam

