

ABBREVIATIONS

EA: Exhaust Air to outside
 OA: Outside Air intake
 RA: Room Air to be exhausted
 SA: Supply Air to inside

INSTALLATION ORIENTATION

Unit must be installed in orientation shown.

NOTE

1. UNLESS OTHERWISE SPECIFIED, DIMENSIONS ARE ROUNDED TO THE NEAREST EIGHTH OF AN INCH.
2. SPECIFICATIONS MAY BE SUBJECT TO CHANGE WITHOUT NOTICE.
3. UNIT AND UNIT DOORS CANNOT BE MIRRORED.
4. FOR CURB DETAILS REFER TO CURB DRAWING.
5. FOR PROJECT SPECIFIC DRAWINGS REFER TO PROJECT SUBMITTAL.

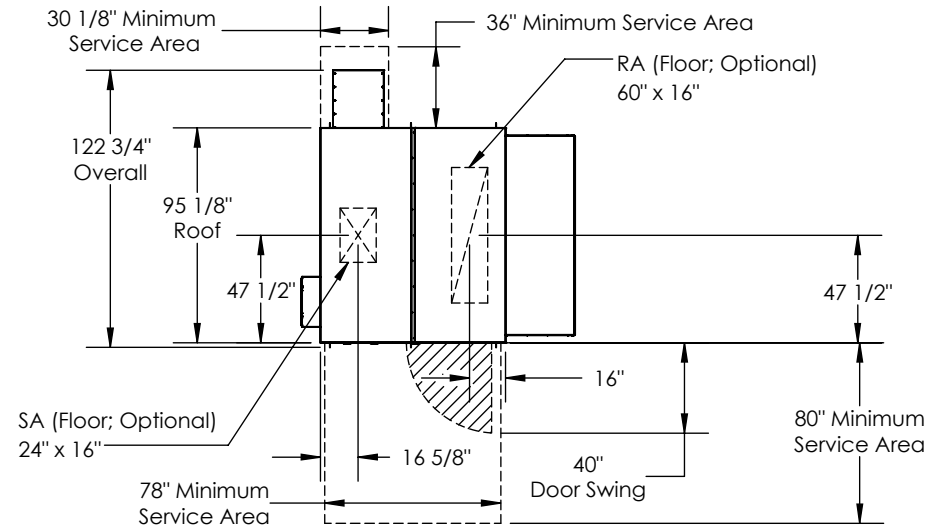

TOP VIEW

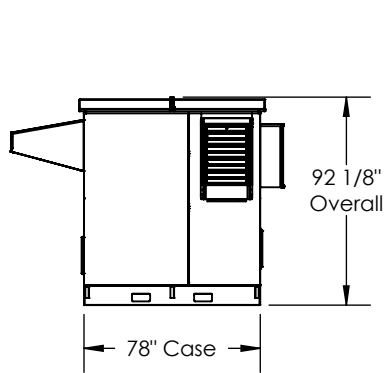

BACK VIEW

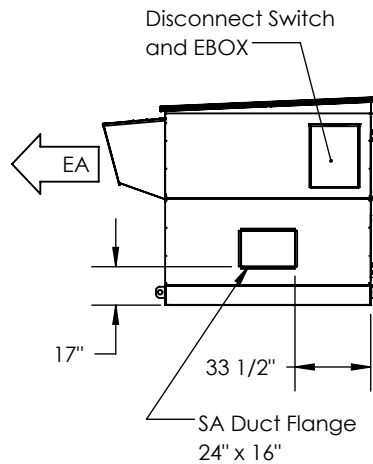

LEFT VIEW

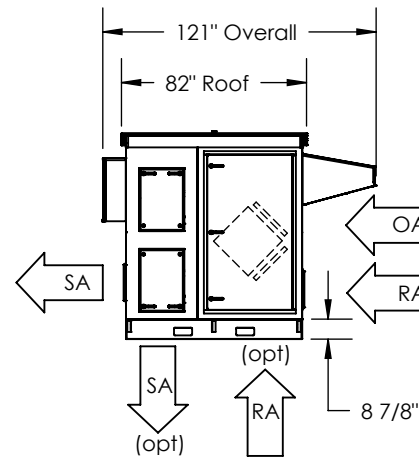

FRONT VIEW

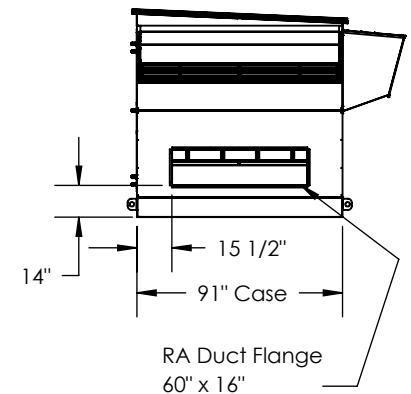

RIGHT VIEW

Model: DN-5JRT ERV 1"
 Drawing Type: Unit Dimension
 Version: DEC18

ERV Only
 No Coils, No Heat

