

**ABBREVIATIONS**

EA: Exhaust Air to outside  
 OA: Outside Air intake  
 RA: Room Air to be exhausted  
 SA: Supply Air to inside  
 CA: Condenser Air

**INSTALLATION ORIENTATION**

Unit must be installed in orientation shown.

**NOTE**

1. UNLESS OTHERWISE SPECIFIED, DIMENSIONS ARE ROUNDED TO THE NEAREST EIGHTH OF AN INCH.

2. SPECIFICATIONS MAY BE SUBJECT TO CHANGE WITHOUT NOTICE.

3. FOR PIPE CONNECTION DETAILS REFER TO CORES OR UNIT SELECTION SUBMITTAL.

4. UNIT, UNIT DOORS, AND COILS CANNOT BE MIRRORED.

5. FOR CURB DETAILS REFER TO CURB DRAWING.

6. FOR PROJECT SPECIFIC DRAWINGS REFER TO PROJECT SUBMITTAL.

7. SCREEN SWING AREA VARIES DEPENDING ON HORIZONTAL OR VERTICAL DUCT CONNECTIONS.

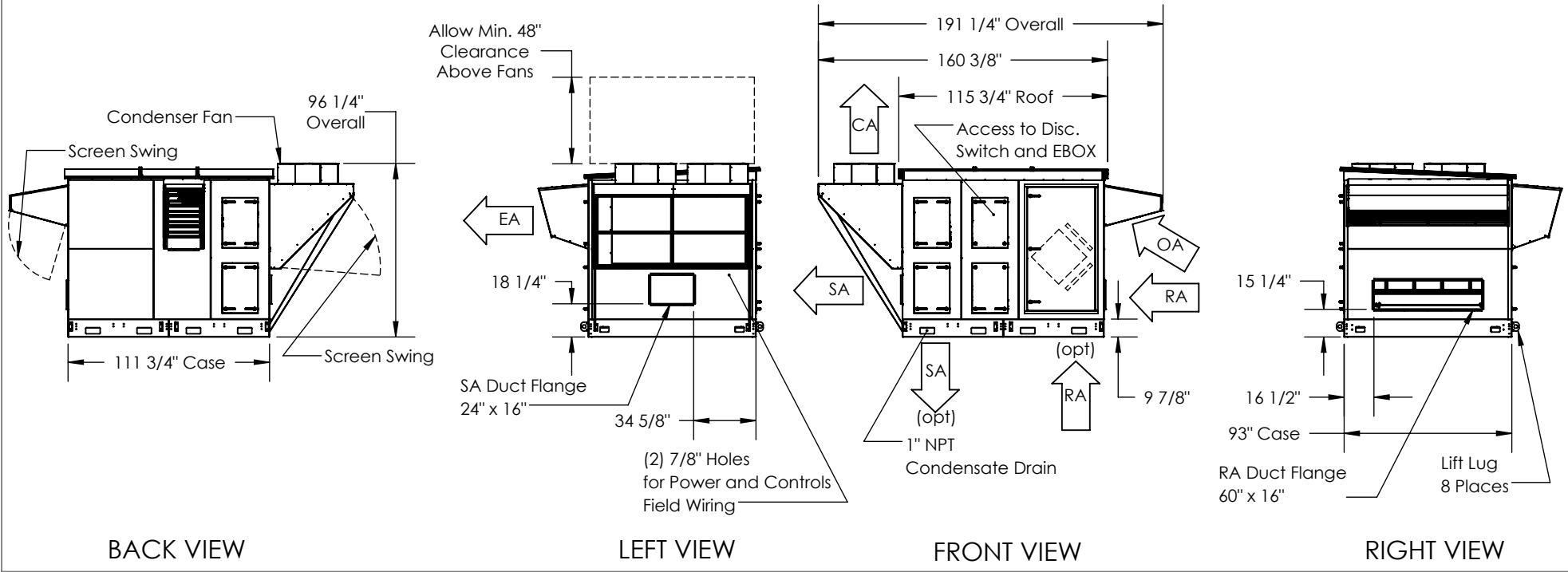
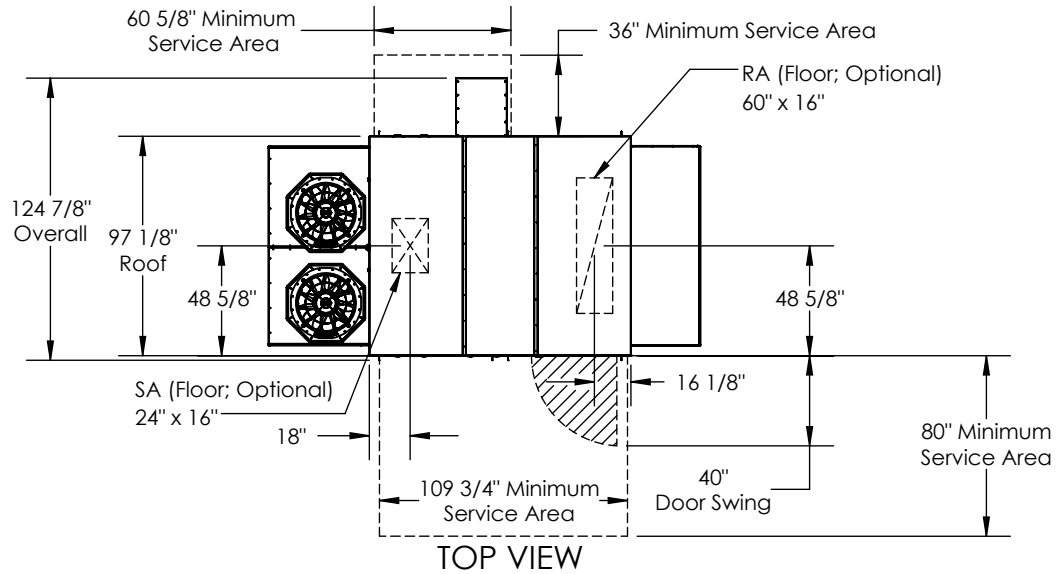

Model: DN-5JRT-PKGD ERV+COIL 2"  
 Drawing Type: Unit Dimension  
 Version: JUN20

Coil Options: DX, HGRH

